

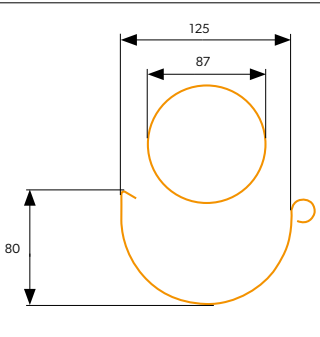

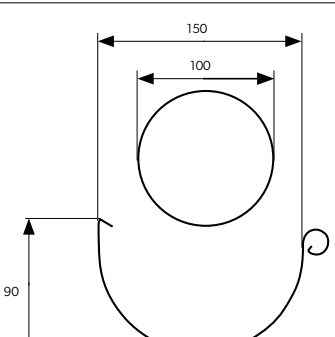







System:	
125/87	150/100
	

Kolor:			
RAL 3011		RAL 7024	
RAL 8004		RAL 8017	
RAL 9005		ALUZINC	
 Technologia druku nie pozwala na wierne oddanie barw, dlatego przedstawione kolory mają charakter orientacyjny i mogą odbiegać od rzeczywistych.			

Rynna	
	dł. 3m, ilość:
	dł. 4m, ilość:

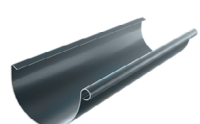
Rura spustowa	
	dł. 1m, ilość:
	dł. 3m, ilość:

Narożnik wewnętrzny	
	90°, ilość:
	135°, ilość:

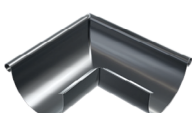
Narożnik zewnętrzny	
	90°, ilość:
	135°, ilość:

Podciąg rynny	
	ilość:

Rewizja	
	ilość:

Łącznik rynien + stabilizator	
	ilość:

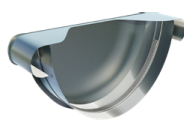
Zaślepka rynny	
	ilość:

Trójnik

	ilość:
---	--------

Ostona narożnika

	ilość:
---	--------

Hak nakrokwiowy

	160mm, ilość:
	210mm, ilość:
	300mm, ilość:

Obejma do dybla skręcana

	ilość:
--	--------

Obejma rury

	ilość:
---	--------

Spray poślizgowy

	ilość:
---	--------

Kolano rury spustowej

	ilość:
---	--------

Odptyw rynny

	125/87, ilość:
	125/100, ilość:
	150/100, ilość:

Wylewka

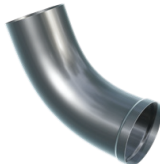
	ilość:
--	--------

Mufa

	ilość:
--	--------

Hak doczołowy

	ilość:
--	--------

Dyble do obejmy skręcanej

	160mm, ilość:
	250mm, ilość:
	300mm, ilość:

Farba zaprawkowa

	ilość:
--	--------



Uwagi

Zakupiony towar nie podlega zwrotowi

Pieczęć

Zamawiający został poinformowany o konieczności zorganizowania rozładunku dostarczonych produktów we własnym zakresie. Oświadcza również, że są mu znane i akceptuje ogólne warunki sprzedaży (OWS), warunki gwarancji, transportu i przechowywania oraz treść i wytyczne instrukcji montażu. Reklamacje na uszkodzenia powstałe w transporcie nie zgłoszone kierowcy przy rozładunku i nie potwierdzone przez niego nie będą rozpatrywane (dotyczy rynien i rur spustowych). Uszkodzenia elementów przesyłanych spedycją należy zgłaszać na adres mailowy: logistyka@bp2.pl

Czytelny podpis

Telefon kontaktowy

BLACHPROFIL 2[®] Sp. z o. o.
ul. Nadwiślańska 11/139
30-527 Kraków

NIP: 6762431701, Regon: 121387608
Nr rejestrowy BDO 00027817
KRS: 0000369912 SR dla Krakowa - Śródmieścia,
Kapitał Zakładowy: 96 838 900,00 zł

Zakłady produkcyjne:
Production plants:

Grojec, ul. Grojecka 39
32-566 Alwernia k/Krakowa

ul. Budowlanych 10
41-303 Dąbrowa Górnicza

Bank Handlowy w Warszawie S.A.
PL95 1030 1508 0000 0008 0325 4001 PLN
PL76 1030 1508 0000 0008 0325 4052 EUR/SWIFT: CITIPLPX

PKO BANK POLSKI S.A.
PL 59 1020 2313 0000 3402 0627 1235 PLN
PL 76 1020 2313 0000 3902 0627 1557 EUR/SWIFT: BPKOPLPW