

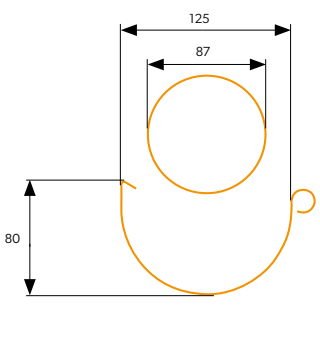

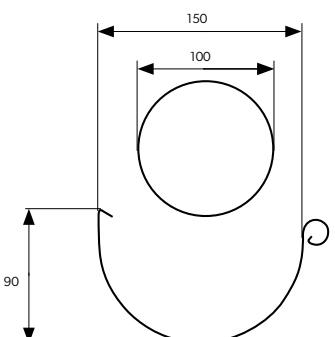





SISTEM:	
125/87	150/100
	

CULOARE:			
RAL 3011		RAL 7024	
RAL 8004		RAL 8017	
RAL 9005		ALUZINC	



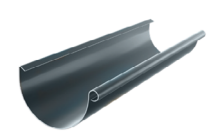

Tehnologiile de imprimare nu permit redarea fidelă a culorilor, așadar, culorile ilustrate sunt aproximative și pot să difere de culorile din realitate.

Jgheab	
	3m, cantitate:
	4m, cantitate:

Burlan	
	1m, cantitate:
	3m, cantitate:

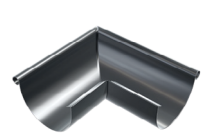
Colțar interior	
	90°, cantitate:
	135°, cantitate:

Colțar exterior	
	90°, cantitate:
	135°, cantitate:

Prelucrare pe lungimea jgheabului	
	cantitate:

Revizia	
	cantitate:

Conector jgheab + stabilizator	
	cantitate:

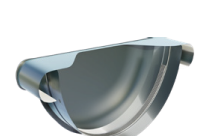
Capac jgheab	
	cantitate:

Teu

	cantitate:
---	------------

Mască colțar

	cantitate:
---	------------

Cârlig pe caprior

	160mm, cantitate:
	210mm, cantitate:
	300mm, cantitate:

Clemă cu dibluri cu șuruburi

	cantitate:
--	------------

Brățară burlan cu fixare fără diblu

	cantitate:
---	------------

Spray antifricțiune

	cantitate:
---	------------

Cot burlan

	cantitate:
---	------------

Bazin colectare

	125/87, cantitate:
	125/100, cantitate:
	150/100, cantitate:

Țeava de scurgere

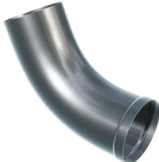
	cantitate:
--	------------

Mufă

	cantitate:
--	------------

Cârlig universal

	cantitate:
--	------------

Dibluri pentru clemă cu șurub

	160mm, cantitate:
	250mm, cantitate:
	300mm, cantitate:

Lac

	cantitate:
--	------------



Note

Produsele cumpărate nu pot fi returnate.

Ștampilă

Clientul a fost informat cu privire la faptul că trebuie să organizeze singur descărcarea produsului livrat. Clientul declară, de asemenea, că a luat la cunoștință condițiile generale de vânzare (GTS), cu condițiile de garanție, transport și depozitare, și cu conținutul și instrucțiunile de instalare și că este de acord cu acestea. Cererile de despăgubire pentru daunele apărute în timpul transportului, care nu au fost raportate șoferului în timpul descărcării și care nu au fost confirmate de către acesta nu vor fi luate în considerare (se referă la jgheaburi și streășine). Deteriorarea articolelor trimise prin expediere trebuie să fie raportată la următoarea adresă de e-mail: [logistyka@bp2.pl](mailto:logistyka@bp2.pl).

Semnătura lizibilă

Nr. de telefon de contact