

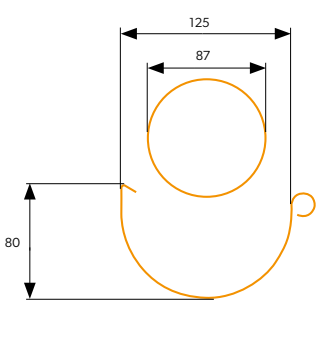

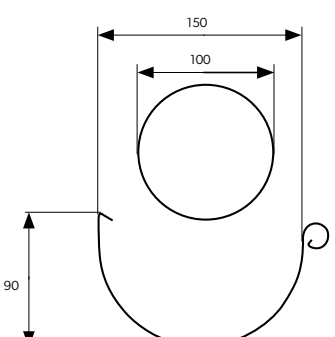







Systém:	
125/87	150/100
	

Farba:			
RAL 3011		RAL 7024	
RAL 8004		RAL 8017	
RAL 9005		ALUZINC	
 Technológia tlače neumožňuje presné zobrazenie farieb, preto sú uvedené farby iba orientačné a môžu sa líšiť od skutočných.			

Odkvapový žľab	
	dĺ. 3m, množstvo:
	dĺ. 4m, množstvo:

Zvodová rúra	
	dĺ. 1m, množstvo:
	dĺ. 3m, množstvo:

Roh vnútorný	
	90°, množstvo:
	135°, množstvo:

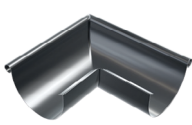
Roh vonkajší	
	90°, množstvo:
	135°, množstvo:

Žľabový hák	
	množstvo:

Revízny otvor	
	množstvo:

Žľabová spojka + stabilizátor	
	množstvo:

Čelo odkvapů	
	množstvo:

Zvodová odbočka

	množstvo:
---	-----------

Kryt rohu

	množstvo:
---	-----------

Hák na krokvu

	160mm, množstvo:
	210mm, množstvo:
	300mm, množstvo:

Skrutkovaná svorka na hmoždinku

	množstvo:
--	-----------

Objímka zvodovej rúry

	množstvo:
---	-----------

Silikónový sprej

	množstvo:
---	-----------

Koleno zvodovej rúry

	množstvo:
---	-----------

Odtok žľabu

	125/87, množstvo:
	125/100, množstvo:
	150/100, množstvo:

Výtokové koleno

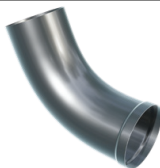
	množstvo:
--	-----------

Spojka zvodovej rúry

	množstvo:
--	-----------

Hák čelný

	množstvo:
--	-----------

Hmoždinky pre skrutkovaciu svorku

	160mm, množstvo:
	250mm, množstvo:
	300mm, množstvo:

Lak

	množstvo:
--	-----------



Poznámky

Zakúpený tovar je nevratný

Pečiatka

Objednávateľ bol informovaný o potrebe organizovať vykládku dodaných výrobkov samostatne. Ďalej vyhlasuje, že je oboznámený a akceptuje všeobecné obchodné podmienky (GTS), záručné podmienky, podmienky prepravy a skladovania, ako aj obsah a pokyny uvedené v montážnom návode. Na reklamácie škôd spôsobených pri preprave, ktoré nebudú nahlásené vodičovi pri vykládke a nebudú ním potvrdené, sa nebude prihliadať (vzťahuje sa na odkvapy a odtoky). Poškodenie vecí zaslaných špedíciou by malo byť hlásené na e-mailovú adresu: logistyka@bp2.pl.

Čitateľný podpis

Telefónne číslo

BLACHPROFIL 2[®] Sp. z o. o.
ul. Nadwiślańska 11/139
30-527 Kraków

NIP: 6762431701, Regon: 121387608
Nr rejestrowy BDO 00027817
KRS: 0000369912 SR dla Krakowa - Śródmieścia,
Kapitał Zakładowy: 96 838 900,00 zł

Zakłady produkcyjne:
Production plants:

Grojec, ul. Grojecka 39
32-566 Alwernia k/Krakowa

ul. Budowlanych 10
41-303 Dąbrowa Górnicza

Bank Handlowy w Warszawie S.A.
PL95 1030 1508 0000 0008 0325 4001 PLN
PL76 1030 1508 0000 0008 0325 4052 EUR/SWIFT: CITIPLPX

PKO BANK POLSKI S.A.
PL 59 1020 2313 0000 3402 0627 1235 PLN
PL 76 1020 2313 0000 3902 0627 1557 EUR/SWIFT: BPKOPLPW