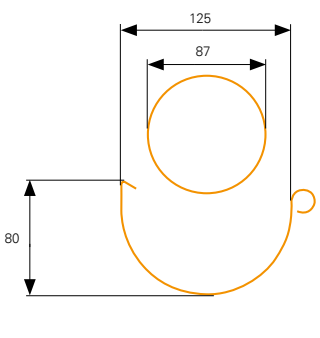
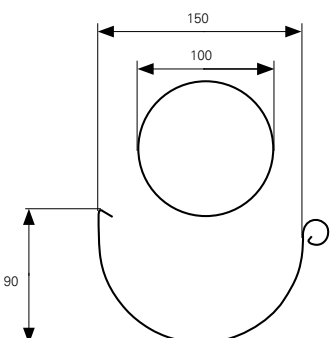
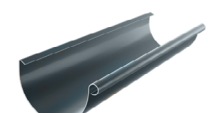

ODKVAPOVÝ SYSTÉM INGURI[®] FORMULÁR OBJEDNÁVKY

System:

125/87	150/100
	

Odkvapový žľab

	dĺ. 3m, množstvo:
	dĺ. 4m, množstvo:

Roh vnútorný

	90°, množstvo:
	135°, množstvo:

Žľabový hák

	množstvo:
--	-----------

Žľabová spojka + stabilizátor

	množstvo:
--	-----------

Odtok žľabu

	125/87, množstvo:
	125/100, množstvo:
	150/100, množstvo:

Farba:

RAL 3011		RAL 7024	
RAL 8004		RAL 8017	
RAL 9005		ALUZINC	

 Technológia tlače neumožňuje presné zobrazenie farieb, preto sú uvedené farby iba orientačné a môžu sa líšiť od skutočných.

Zvodová rúra

	dĺ. 1m, množstvo:
	dĺ. 3m, množstvo:

Roh vonkajší

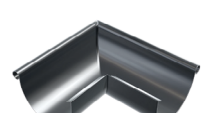
	90°, množstvo:
	135°, množstvo:

Revízny otvor

	množstvo:
---	-----------

Čelo odkvapů

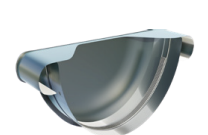
	množstvo:
--	-----------

Koleno zvodovej rúry

	množstvo:
---	-----------

Zvodová odbočka

	množstvo:
---	-----------

Kryt rohu

	množstvo:
---	-----------

Hák na krokvu

	160mm, množstvo:
	210mm, množstvo:
	300mm, množstvo:

Skrutkovaná svorka na hmoždinku

	množstvo:
---	-----------

Objímka zvodovej rúry

	množstvo:
---	-----------

Kolíky k objímke

	160mm, množstvo:
	250mm, množstvo:
	300mm, množstvo:

Silikónový sprej

	množstvo:
---	-----------

Výtokové koleno

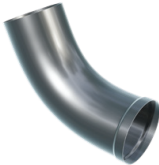
	množstvo:
--	-----------

Spojka zvodovej rúry

	množstvo:
--	-----------

Hák čelný

	množstvo:
--	-----------

Hmoždinky pre skrutkovaciu svorku

	160mm, množstvo:
	250mm, množstvo:
	300mm, množstvo:

Objímka rúry ku kolíku

	množstvo:
--	-----------

Lak

	množstvo:
--	-----------

Poznámky

Zakúpený tovar je nevratný

Pečiatka

Objednávateľ bol informovaný o potrebe organizovať vykládku dodaných výrobkov samostatne. Ďalej vyhlasuje, že je oboznámený a akceptuje všeobecné obchodné podmienky (GTS), záručné podmienky, podmienky prepravy a skladovania, ako aj obsah a pokyny uvedené v montážnom návode. Na reklamácie škôd spôsobených pri preprave, ktoré nebudú nahlásené vodičovi pri vykládke a nebudú ním potvrdené, sa nebude prihliadať (vzťahuje sa na odkvapy a odtoky). Poškodenie vecí zaslaných špedíciou by malo byť hlásené na e-mailovú adresu: logistyka@bp2.pl.

Čitateľný podpis

Telefónne číslo