

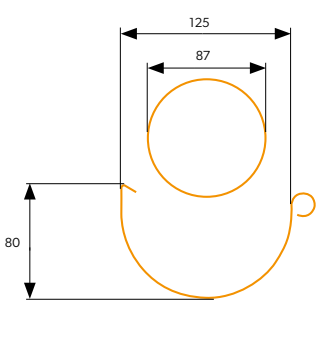

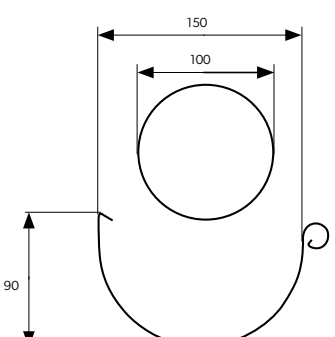







Systém:	
125/87	150/100
	

Barva:			
RAL 3011		RAL 7024	
RAL 8004		RAL 8017	
RAL 9005		ALUZINC	
 Technologie tisku neumožňuje přesné zobrazení barev, proto jsou uvedené barvy pouze orientační a mohou se lišit od skutečných.			

Okapový žlab	
	dř. 3m, množství:
	dř. 4m, množství:

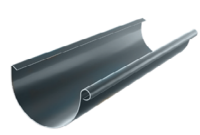
Svodová roura	
	dř. 1m, množství:
	dř. 3m, množství:

Žlabový kout	
	90°, množství:
	135°, množství:

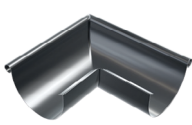
Žlabový roh	
	90°, množství:
	135°, množství:

Úchyt žlabu	
	množství:

Zachytávač nečistot	
	množství:

Žlabová spojka + stabilizátor	
	množství:

Čelo žlabu	
	množství:

Odskok do svodu

	množství:
---	-----------

Zábrana přelití

	množství:
---	-----------

Rovný žlabový hák na krokve

	160mm, množství:
	210mm, množství:
	300mm, množství:

Šroubovací trn k objímce

	množství:
--	-----------

Objímka svodu

	množství:
---	-----------

Kluzný sprej

	množství:
---	-----------

Koleno svodové roury

	množství:
---	-----------

Odtok žlabu (kotlík)

	125/87, množství:
	125/100, množství:
	150/100, množství:

Výtokové koleno

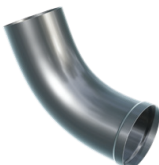
	množství:
--	-----------

Svodová spojka

	množství:
--	-----------

Nástěnný žlabový hák

	množství:
--	-----------

Hmoždinky k šroubovacímu trnu

	160mm, množství:
	250mm, množství:
	300mm, množství:

Lak

	množství:
--	-----------



Poznámky

Zakoupené zboží je nevratné

Razítko

Objednatel byl informován o potřebě organizovat vykládku dodaných produktů samostatně. Rovněž prohlašuje, že je seznámen s všeobecnými podmínkami prodeje (GTS), záručními, přepravními a skladovacími podmínkami a souhlasí s nimi stejně jako obsah a pokyny montážního návodu. Na reklamace škod způsobených při přepravě, které nebyly nahlášeny řidiči při vykládce a nebyly jím potvrzeny, nebudou brány v úvahu (platí pro žlaby a svody). Poškození položek zaslaných prostřednictvím spedice by mělo být nahlášeno na e-mailovou adresu: logistyka@bp2.pl.

Čitelný podpis

Telefonní číslo

BLACHPROFIL 2[®] Sp. z o. o.
ul. Nadwiślańska 11/139
30-527 Kraków

NIP: 6762431701, Regon: 121387608
Nr rejestrowy BDO 00027817
KRS: 0000369912 SR dla Krakowa - Śródmieścia,
Kapitał Zakładowy: 96 838 900,00 zł

Zakłady produkcyjne:
Production plants:

Grojec, ul. Grojecka 39
32-566 Alwernia k/Krakowa

ul. Budowlanych 10
41-303 Dąbrowa Górnicza

Bank Handlowy w Warszawie S.A.
PL95 1030 1508 0000 0008 0325 4001 PLN
PL76 1030 1508 0000 0008 0325 4052 EUR/SWIFT: CITIPLPX

PKO BANK POLSKI S.A.
PL 59 1020 2313 0000 3402 0627 1235 PLN
PL 76 1020 2313 0000 3902 0627 1557 EUR/SWIFT: BPKOPLPW