

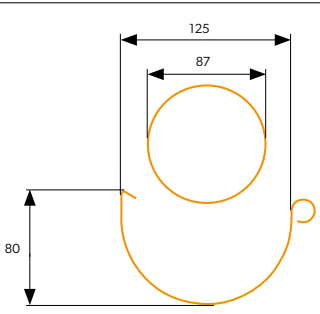

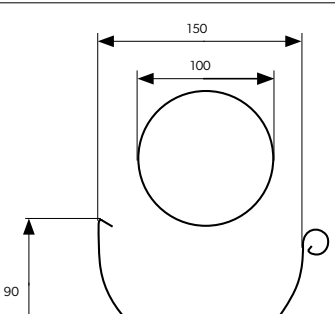





Sistema:	
125/87	150/100
	

Spalva:			
RAL 3011		RAL 7024	
RAL 8004		RAL 8017	
RAL 9005		ALUZINC	
 Spaudos technologija neleidžia tiksliai pateikti spalvų, todėl pateikiamos spalvos yra apytikrės ir gali skirtis nuo tikrųjų.			

Latakas	
	3m, kiekis:
	4m, kiekis:

Lietvamzdis	
	1m, kiekis:
	3m, kiekis:

Vidinis kampas	
	90°, kiekis:
	135°, kiekis:

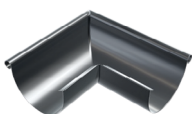
Išorinis kampas	
	90°, kiekis:
	135°, kiekis:

Atrama tvirtinimui	
	kiekis:

Revizija	
	kiekis:

Latakų jungiamasis elementas + stabilizatorius	
	kiekis:

Latako galinis dangtelis	
	kiekis:

**Trišakis**

	kiekis:
---	---------

**Kampo gaubtas**

	kiekis:
---	---------

**Ilgasis latakų laikiklis**

	160mm, kiekis:
	210mm, kiekis:
	300mm, kiekis:

**Lietvamzdžio laikiklis su sąvarža**

	kiekis:
--	---------

**Laikiklio su sąvarža varžtas**

	kiekis:
---	---------

**Purškiamasis sandariklis**

	kiekis:
---	---------

**Višutinė alkūnė**

	kiekis:
---	---------

**Latakų santaka**

	125/87, kiekis:
	125/100, kiekis:
	150/100, kiekis:

**Apatinė alkūnė**

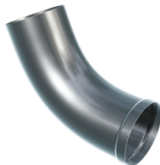
	kiekis:
--	---------

**Lietvamzdžio jungtis**

	kiekis:
--	---------

**Latakų laikiklis universalus**

	kiekis:
--	---------

**Laikiklio su sąvarža varžtas**

	160mm, kiekis:
	250mm, kiekis:
	300mm, kiekis:

**Apsauginiai dažai**

	kiekis:
--	---------



---

Pastabos

---

Įsigytos prekės negražinamos

Antspaudas

Užsakovui pranešta, kad privalo suorganizuoti pristatytų gaminių iškrovimą savo jėgomis. Taip pat pareiškia, kad jam žinomos bendrosios pardavimo sąlygos (BPS), garantijos, gabenimo ir laikymo sąlygos bei tvirtinimo instrukcijos turinys ir nurodymai ir su jais sutinka. Skundai dėl pažeidimų, atsiradusių gabenant, kurie nepateikti vairuotojui iškraunant ir jo nepatvirtinti, nepriimami (taikoma latakams ir nuleidžiamiesiems vamzdžiams). Apie elementų, kurie siunčiami tarpininkaujant ekspedijavimo įmonei, pažeidimus būtina pranešti e. pašto adresu [logistyka@bp2.pl](mailto:logistyka@bp2.pl).

Įskaitomas parašas

Kontaktinis telefonas

**BLACHPROFIL 2<sup>®</sup> Sp. z o. o.**  
ul. Nadwiślańska 11/139  
30-527 Kraków

NIP: 6762431701, Regon: 121387608  
Nr rejestrowy BDO 00027817  
KRS: 0000369912 SR dla Krakowa - Śródmieście,  
Kapitał Zakładowy: 96 838 900,00 zł

**Zakłady produkcyjne:**  
**Production plants:**

Grojec, ul. Grojecka 39  
32-566 Alwernia k/Krakowa

ul. Budowlanych 10  
41-303 Dąbrowa Górnicza

Bank Handlowy w Warszawie S.A.  
PL95 1030 1508 0000 0008 0325 4001 PLN  
PL76 1030 1508 0000 0008 0325 4052 EUR/SWIFT: CITIPLPX

PKO BANK POLSKI S.A.  
PL 59 1020 2313 0000 3402 0627 1235 PLN  
PL 76 1020 2313 0000 3902 0627 1557 EUR/SWIFT: BPKOPLPW